

Impexa 2.4 GHz SMD Antenna

Part No. A6150 / A6250

Product Specification

1 Features

- Designed for 2.4 GHz applications: Bluetooth[®], Wi-Fi[®] (802.11b/g), ZigBee[®], etc.
- Easy to integrate
- Low profile design for use with no ground beneath the antenna
- High efficiency
- Light weight
- Intended for SMD mounting
- Supplied in tape on reel

2 Description

Impexa is intended for use with all 2.4 GHz applications. The antenna uses a ground plane in order to radiate efficiently, but this ground plane must not extend underneath the antenna itself.

The antenna is available in two versions with the feed locations on the right or left of the antenna.

3 Applications

- Mobile phones
- PDAs
- PNDs
- Headsets
- PMPs / MP3s
- Laptops
- PC-Cards
- Sensors



4 Part numbers

Impexa Left: A6150



Impexa Right: A6250



5 General data

Product name	Impexa 2.4 GHz
Part Number	A6150 (Left)
	A6250 (Right)
Frequency	2.4 – 2.5 GHz
Polarization	Linear
Operating temperature	-40 °C to +85 °C
Impedance with matching	50 Ω
Weight	0.05 g
Antenna type	SMD
Dimensions	6.1 x 3.9 x 1.1 [mm]

6 Electrical characteristics

	Typical performance	Conditions
Peak gain	1.0 dBi	All data measured on Antenna's reference boards, part numbers A6150-U1 and A6250-U1 Data given for the 2.4 – 2.5 GHz frequency range
Average gain	-1.9 dBi	
Average efficiency	65%	
Maximum Return Loss	-10 dB	
Maximum VSWR	1.9:1	

7 Electrical performance

7-1 Return Loss

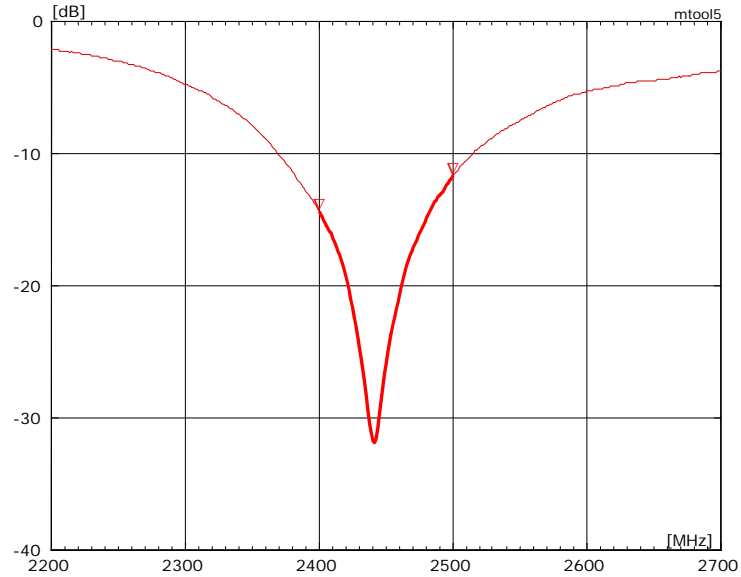

7-2 VSWR

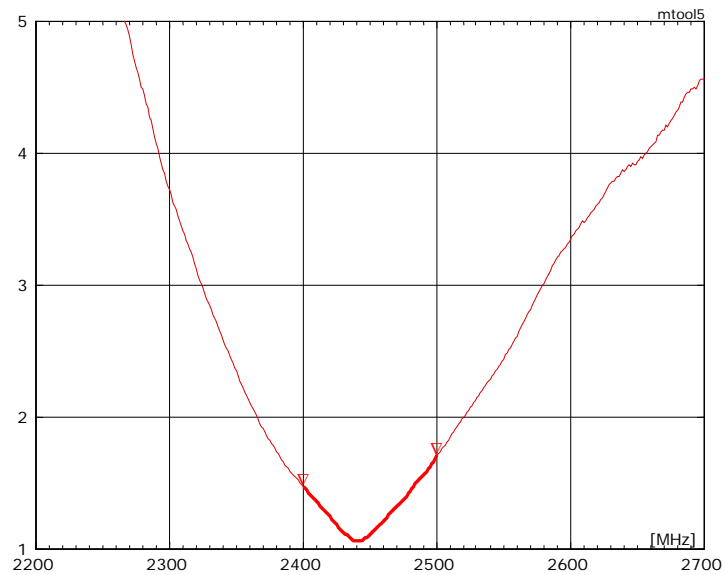

7-3 Antenna patterns

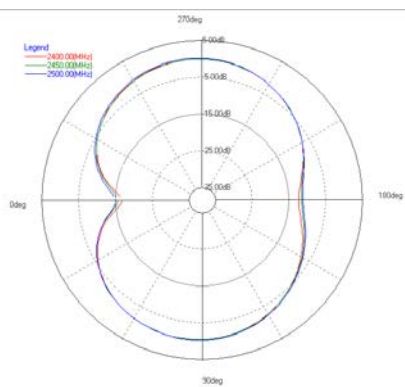
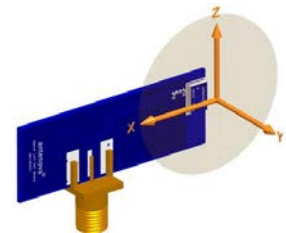
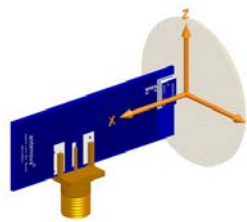
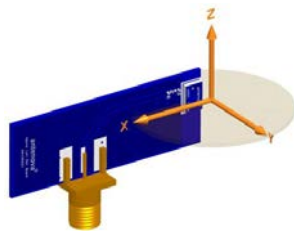
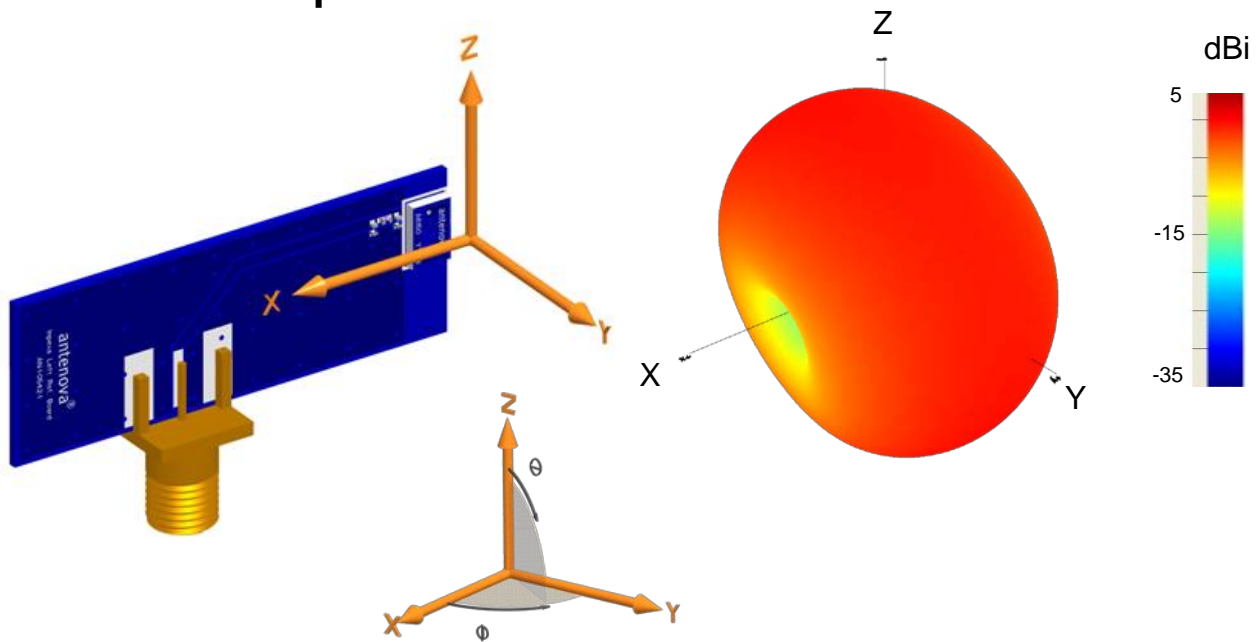

XY plane

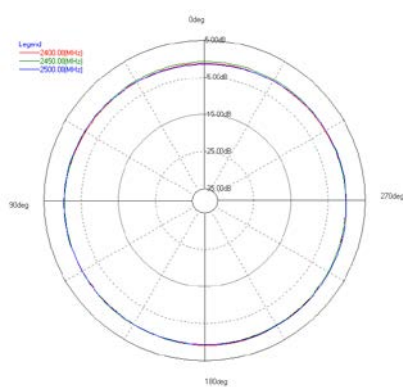

ZY plane

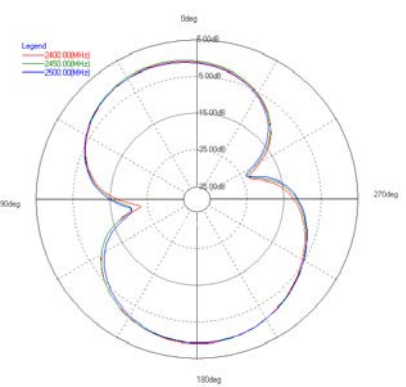

XZ plane

Patterns show combined polarisations
measured on reference board A6150-U1

8 Antenna dimensions

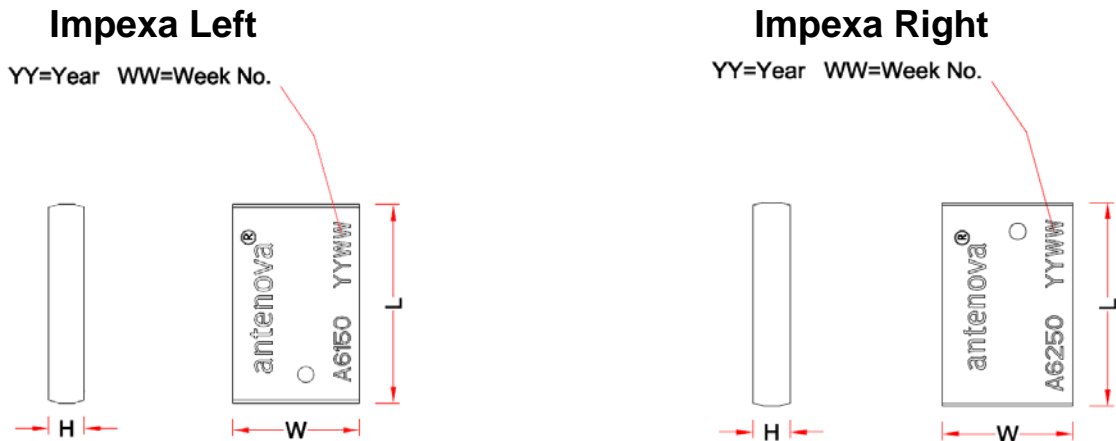

L	W	H
Length	Width	Height
6.1 ± 0.2	3.9 ± 0.2	1.1 ± 0.2

Dimensions in mm

9 Antenna footprint

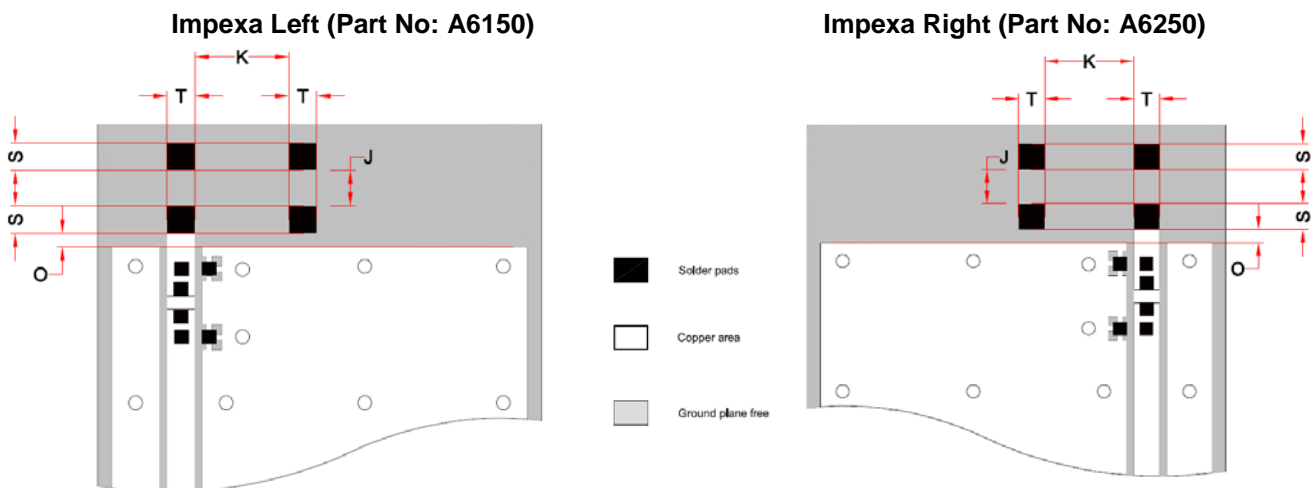

* CAD files of the antenna footprint are available from AntenoVA M2M on request.
Please contact sales@antenoVA-m2m.com for further details.

J	K	O	S	T
1.3 ± 0.1	3.4 ± 0.1	≥ 0.5 ± 0.1	1 ± 0.1	1 ± 0.1

Dimensions in mm

Dimension O stated is a minimum. Depending on the application, it can be increased to optimise the antenna performance. For more details, please contact sales@antenoVA-m2m.com

10 Electrical interface

10-1 Transmission lines

- All transmission lines should be designed to have a characteristic impedance of 50 Ω
- The length of the transmission lines should be kept to a minimum
- Any other parts of the RF system like transceivers, power amplifiers, etc, should also be designed to have an impedance of 50 Ω

Once the material for the PCB has been chosen (PCB thickness and dielectric constant), a coplanar transmission line can easily be designed using any of the commercial software packages for transmission line design. For the chosen PCB thickness, copper thickness and substrate dielectric constant, the program will calculate the appropriate transmission line width and gaps on either side of the track so the characteristic impedance of the coplanar transmission line is 50 Ω .

10-2 Matching circuit

The antenna requires a matching circuit that must be optimized for each customer's product. The matching circuit will require up to three components and the following pad layout should be designed into the device so the correct circuit can be installed.

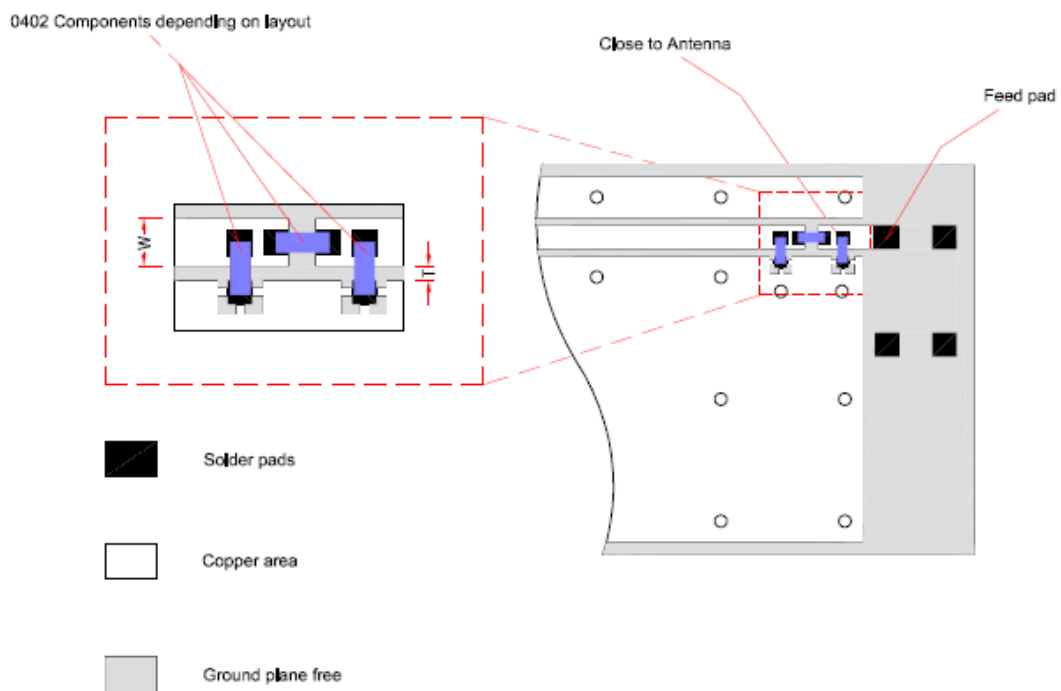

The antenna feed pad is indicated in the drawing above. Additional pads are for mechanical attachment only and should not be grounded.

In addition to the matching circuit, a separate DC blocking capacitor will also be required between the radio and the antenna matching circuit.

Note: The component values for the matching circuit will vary depending on the size of the PCB and surrounding components. The impedance of the antenna should be measured before selecting suitable matching components. Antenova M2M offers this service on request. Contact sales@antenova-m2m.com for further information.

10-3 Antenna placement

Antenova M2M strongly recommends placing the antenna near the edge of the board. Maximum antenna performance is achieved by placing the antenna towards one of the corners of the PCB.

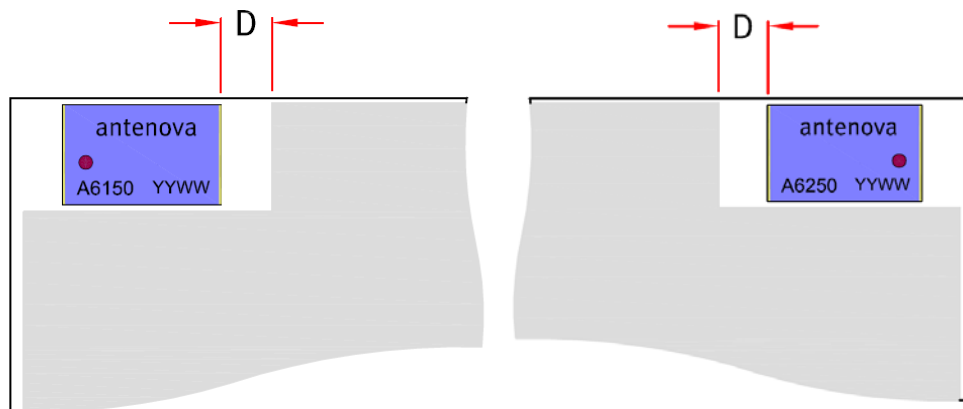

Additional ground and components near the antenna should be at a distance of at least 2 mm. Where possible the antenna should be clear of ground from both sides, although the antenna can work well with a minimum clearance of $D \geq 2$ mm as shown in the drawing above.

10-4 Reference boards

The reference boards have been designed for evaluation purposes of Impexa 2.4 GHz and they include a SMA female connector

Impexa Left
Part No. A6150-U1

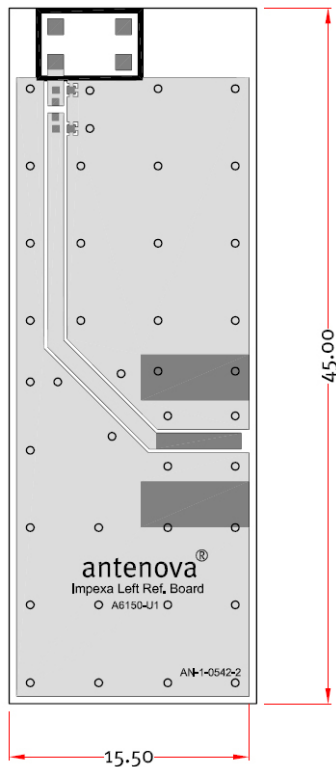

Impexa Right
Part No. A6250-U1

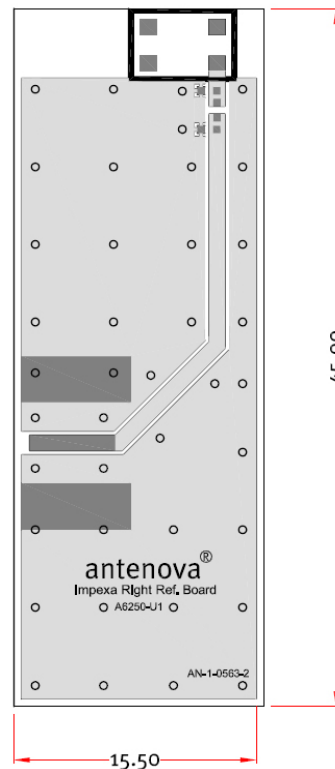

Dimensions in mm

To order a reference board contact sales@antenna-m2m.com.

11 Soldering

This antenna is suitable for lead free soldering.

The reflow profile should be adjusted to suit the device, oven and solder paste, while observing the following conditions:

- The maximum temperature should not exceed 240 °C
- However for lead free soldering, a maximum temperature of 255 °C for no more than 20 seconds is permitted.
- The antenna should not be exposed to temperatures exceeding 120 °C more than 3 times during the soldering process.

12 Hazardous material regulation conformance

The antenna has been tested to conform to RoHS requirements. A certificate of conformance is available from Antenova M2M's website.

13 Packaging

13-1 Optimal storage conditions for packaged reels

Temperature	-10°C to 40°C
Humidity	Less than 75% RH
Shelf Life	18 Months
Storage place	Away from corrosive gas and direct sunlight
Packaging	Reels should be stored in unopened sealed manufacturer's plastic packaging.

Note: Storage of open reels of antennas is not recommended due to possible oxidization of pads on antennas. If short term storage is necessary, then it is highly recommended that the bag containing the antenna reel is re-sealed and stored in like storage conditions as in above table.

13-2 Tape characteristics

Impexa Left [Part Number: A6150]

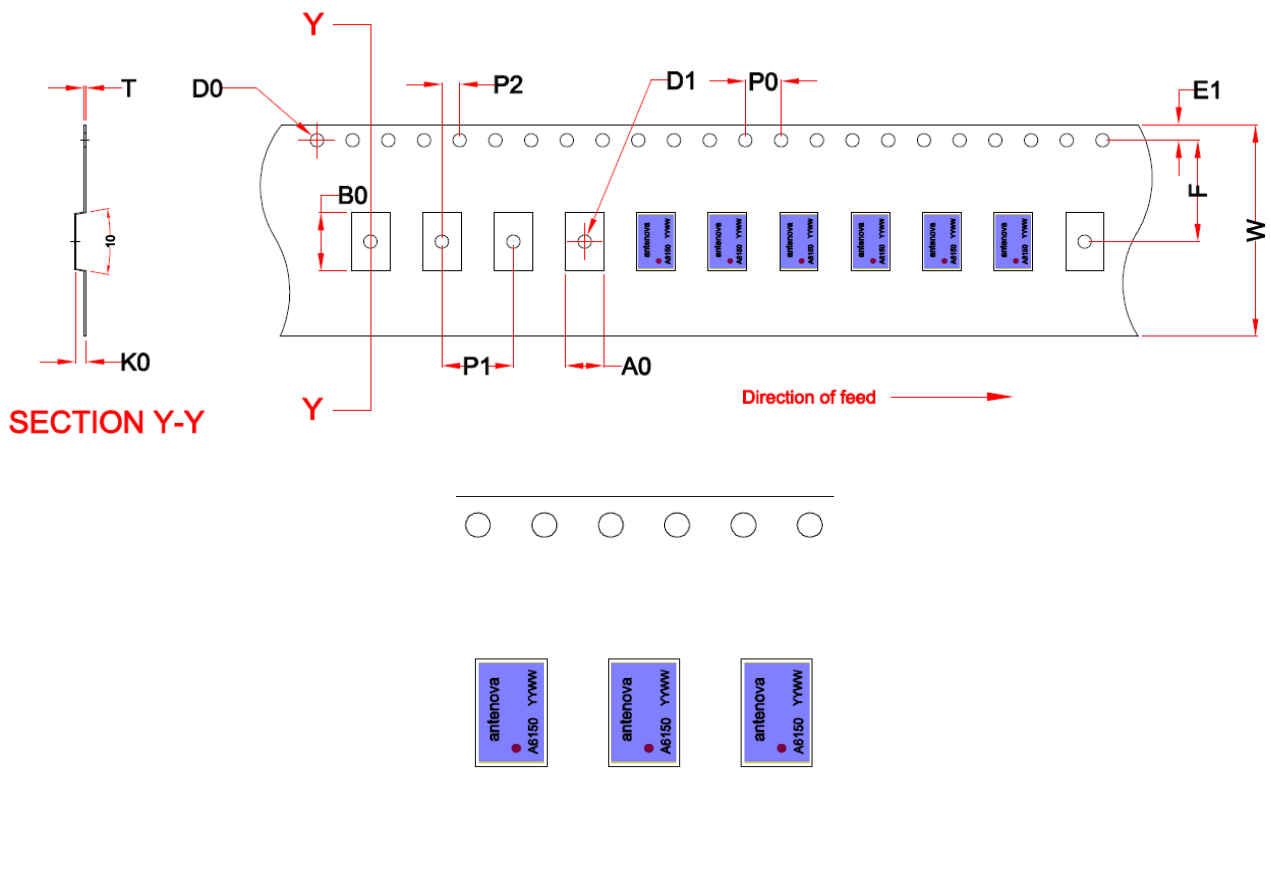

W	F	E1	P0	P1	P2	A0	B0	K0	T	D0	D1
24 ± 0.3	11.5 ± 0.1	1.75 ± 0.1	4 ± 0.1	8 ± 0.1	2 ± 0.1	4.3 ± 0.2	6.6 ± 0.2	1.5 ± 0.2	0.3 ± 0.05	Min 1.5	Min 1.5

Dimensions in mm

Quantity	Leading Space	Trailing Space
1000 pcs / reel	50 blank antenna holders	37 blank antenna holders

Impexa Right [Part Number: A6250]

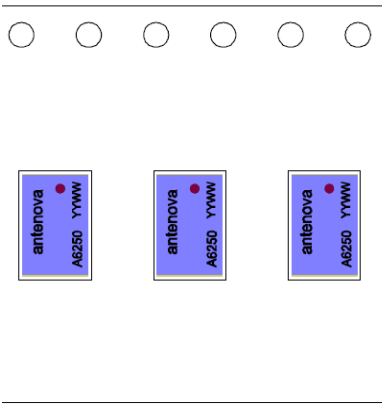
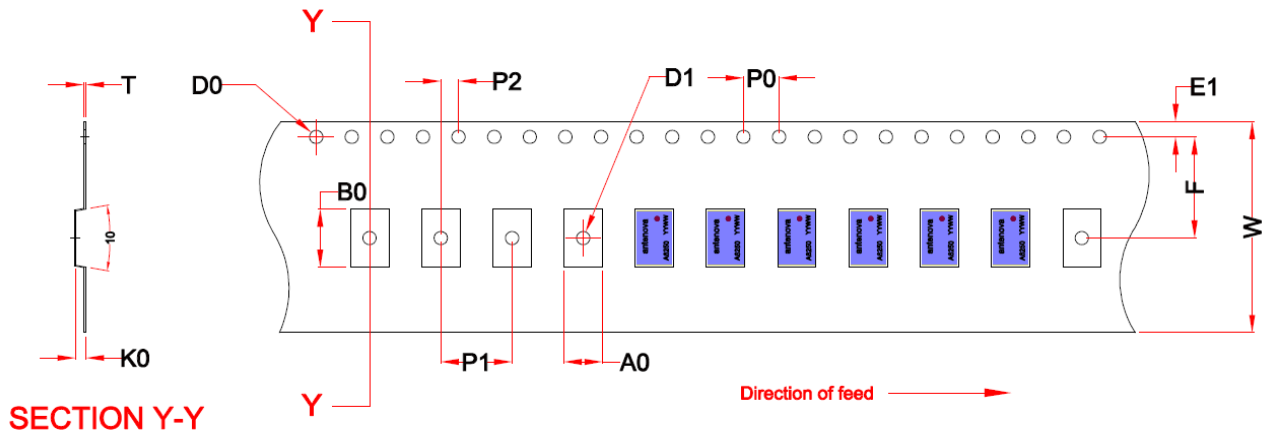

W	F	E1	P0	P1	P2	A0	B0	K0	T	D0	D1
24 ± 0.3	11.5 ± 0.1	1.75 ± 0.1	4 ± 0.1	8 ± 0.1	2 ± 0.1	4.3 ± 0.2	6.6 ± 0.2	1.5 ± 0.2	0.3 ± 0.05	Min 1.5	Min 1.5

Dimensions in mm

Quantity	Leading Space	Trailing Space
1000 pcs / reel	50 blank antenna holders	37 blank antenna holders

13-3 Reel dimensions

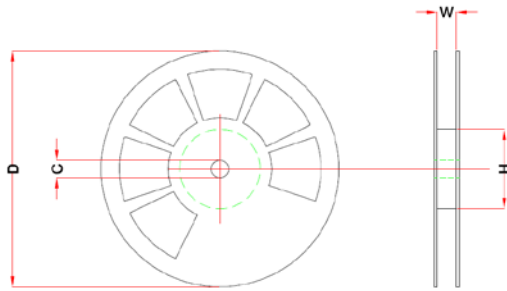

Width	Reel Diameter	Hub Diameter	Shaft Diameter
24 mm	180 mm (7")	50 mm (2")	13 mm

13-4 Box dimensions



Width W	Breadth B	Thickness H
195 mm	195 mm	37 mm

13-5 Bag properties

Reels are supplied in protective plastic packaging

13-6 Reel label information

Impexa Left

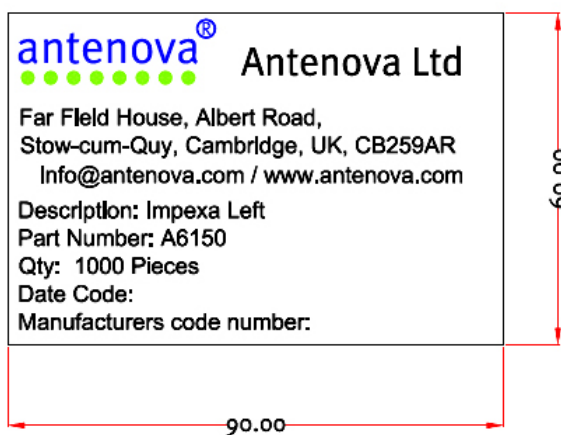

Impexa Right

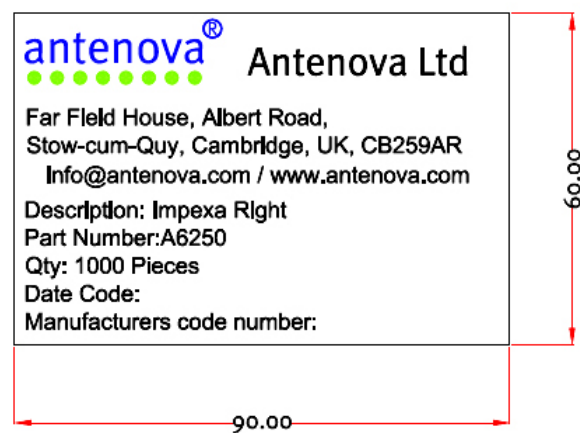

Dimensions in mm



www.antenova-m2m.com

Corporate Headquarters

Antenova Ltd.
Far Field House
Albert Road
Stow-cum-Quy
Cambridge
CB25 9AR

Tel: +44 1223 810600
Fax: +44 1223 810650
Email: sales@antenova-m2m.com

North America Headquarters

Antenova Ltd.
Rogers Business Park
2541 Technology Drive Suite 403
Elgin, IL 60124

Tel: +1 (847) 551 9710
Fax: +1 (847) 551 9719
Email: sales@antenova-m2m.com

Asia Headquarters

Antenova Asia Ltd.
4F, No. 324, Sec. 1, Nei-Hu Road
Nei-Hu District
Taipei 11493
Taiwan, ROC

Tel: +886 (0) 2 8797 8630
Fax: +886 (0) 2 8797 6890
Email: sales@antenova-m2m.com

Copyright® 2013 **Antenova Ltd.** All Rights Reserved. Antenova®, Antenova M2M, gigaNOVA®, and the Antenova and Antenova M2M logos are trademarks and/or registered trademarks of Antenova Ltd. Any other names and/or trademarks belong to their respective companies.

The materials provided herein are believed to be reliable and correct at the time of print. Antenova does not warrant the accuracy or completeness of the information, text, graphics or other items contained within these information. Antenova further assumes no responsibility for the use of this information, and all such information shall be entirely at the user's risk.



Certificate No: 4598

Antennas for Wireless M2M Applications